



# User's manual





## Revision History

Changes to the original manual are listed below:

<b>Version</b>	<b>Date</b>	<b>Description of Version</b>
1.0	September. 03, 2010	Initial release
1.1	February 21, 2011	Added Power save mode and examples for trigger command.
1.2	June 22, 2011	Added description in Edge Trigger Command

# Important Notice

No warranty of any kind is made in regard to this material, including, but not limited to, implied warranties of merchantability or fitness for a particular purpose. We are not liable for any errors contained herein or incidental or consequential damages in connection with furnishing, performance or use of this material.

No part of this document may be reproduced, transmitted, stored in a retrieval system, transcribed, or translated into any language or computer language in any form or by any means electronic, mechanical, magnetic, optical, chemical, manual or otherwise, without express written consent and authorization.

We reserve the right to make changes in product design without reservation and without notification. The material in this guide is for information only and is subject to change without notice.

All trademarks mentioned herein, registered or otherwise, are the properties of their various respective owners.

Copyright © 2011. All rights reserved.

## For CE-Countries

This scanner is in conformity with CE standards. Please note that an approved, CE-marked power supply unit should be used in order to maintain CE conformance.

## Guidance for Printing

1. This manual is in A5 size. Please double check your printer setting before printing it out.
2. When printing barcodes for programming, the use of a high-resolution laser printer is strongly suggested for the best scan result.

## Table of Contents

Important Notice .....	ii
Instruction .....	1
Maintaining the Scanner .....	1
Overview .....	2
Components .....	2
Mounting.....	3
Blink Mode.....	4
Scan Zone .....	4
Connection .....	5
Keyboard Wedge connection for K/PS2 compatible terminal.....	5
RS-232C interface uses detachable cable.....	5
USB Interface with Type A detachable cable.....	6
Technical Specification .....	7
Dimension .....	9
Programming Guide .....	10
Programming Procedure .....	11
Default Parameters .....	12
Scanner Operation .....	12
Interface Communication .....	12
Symbologies .....	13
Data Formating .....	14
Trigger Command Format .....	15
Parameter Setting .....	16
Scanner Operation .....	16
Interface Configuration .....	25
The Symbologies .....	33
Data Editing.....	56
Appendix 1: USB Virtual COM Driver Installation .....	59
Appendix 2: Barcode Length Setting.....	60
Appendix 3: Full ASCII Code 39 Table.....	61



# Instruction

With an easy-to-integrate design and an outstanding scanning performance, this middle-range CCD scan module is especially made for embedded scanning solution. Its powerful linear CCD array enables 330 scans per second with a minimum resolution of 4mil for fast scans.

The scan module offers multiple interfaces including keyboard, RS-232C, and HID USB. Besides, it has three mounting holes on the back of the case reserved for quick and easy installation into your equipment. When working in field, its two-color LED in the front gives immediate scanning response and the programmable tone and beep time are to meet users' need and enhance productivity.

The module has a newly designed CCD scan engine with light beam bright and clear as laser beam that gives user best visual indication and its powerful high resolution CCD acts in remarkable performance.

## Maintaining the Scanner

---

The scanner is designed for long-term trouble-free operation and rarely requires any maintenance. Only an occasional cleaning of the scanner window is necessary in order to remove dirt and fingerprints.

Wipe the scan window with a soft lint-free cloth and a non-abrasive cleaner to avoid scratching and damaging the scan window. The scan window may be cleaned while the scanner is running.



Scratching the scanner window can reduce the scanning performance. It is suggested to either recess the window into the housing or apply a hard-coat on window.

# Overview

---

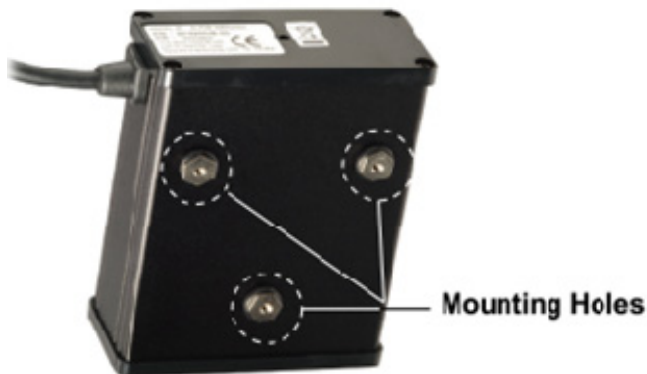

## Components

Description	Function
Exit Window	CCD aperture
Interface Cable	Used to connect to the host
Good Read LED	Indicates a successful reading
Mounting Holes	For mounting the device



# Mounting

The scanner is designed to be easily embed into any space limited devices, and it has 3 screwed mounting holes reserved at the bottom.

- Screw description: M2 \* 0.4
- Depth = 4.5mm
- Screw quantity: 3 pieces

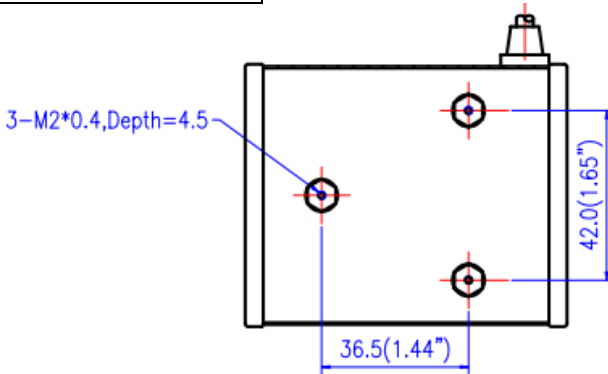

**Figure 1: Screw Position**

To ensure the scanner reaches its best performance, the following points need to be noticed when mounting the scanner:

- (a) Do not place the scanner under direct sunlight or any other bright light source illuminating.
- (b) When placing the barcode label, one must be careful not to over tilt, skew and/or pitch the barcode
- (c) Do not place the device at specula reflection position. The LED light of the scanner reflects directly back on the scanner if it is placed at specula reflection position. As to the nature of CCD sensor, it will not be able to read any barcodes.
- (d) The barcode label must be placed within the effective depth of field (D.O.F.) since it is the effective reading distance for the barcode from the scanner. For the best placing position, please refer to the Decode Depth of Field drawing (Figure 2).

# Blink Mode

After the scanner has been inactive for a period of time, the light beam would automatically start blinking. To stop the scanner from blinking, simply present an object close to the scanner window. The Blink Mode feature is included to reduce power consumption and to extend scanner life.

# Scan Zone



Different quality and density of a barcode could effect the decode depth of field. Usually when a barcode has poor printing quality or high density, the depth of field would be shorter. It is highly suggested **not** place the barcode label at the extremes of depth of field as it is often easy to move out from the reading range.

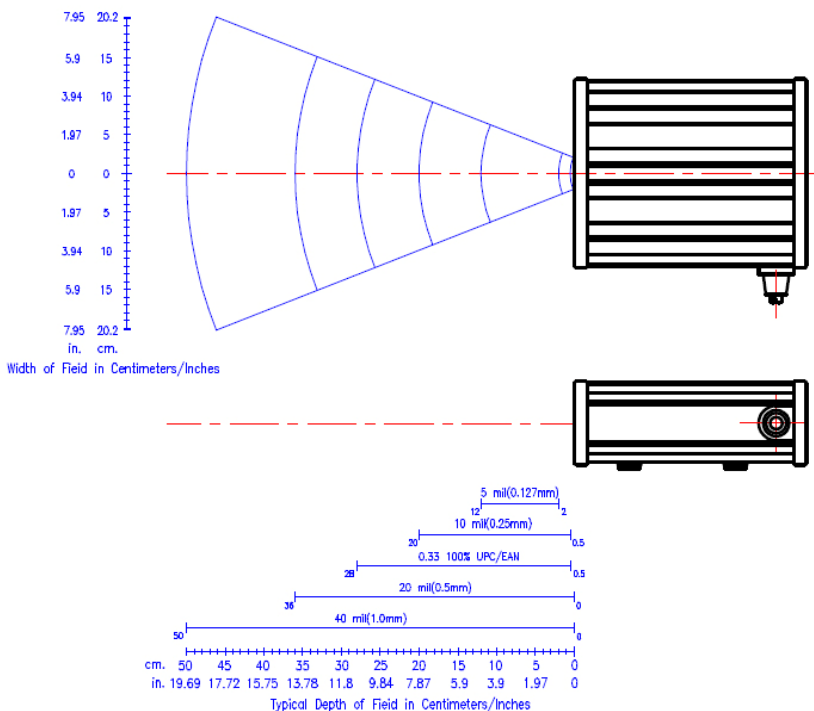

Figure 2: Scan Zone

# Connection

The scan module has 3 different kinds of interface connection to suit customer's desire; the standard cable is black, straight and 2m (6.5 feet) in length. Below shows the connector types and pin out configuration for each interface.

## Keyboard Wedge connection for K/PS2 compatible terminal

### K TYPE MINI DIN(M)+ MINI DIN(F)

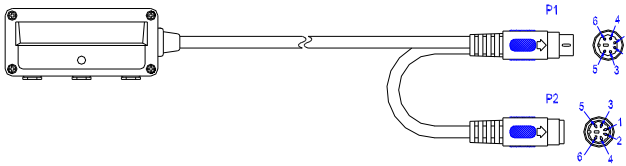

PIN-OUT CONFIGURATION			
MINI DIN (M)		MINI DIN(F)	
DIN	FUNATION	DIN	FUNATION
1	PC Data	1	KB Data
2	N.C.	2	N.C.
3	GND	3	GND
4	+5V	4	+5V
5	PC Clock	5	KB Clock
6	N.C.	6	N.C.

## RS-232C interface uses detachable cable

Please select a suitable cable from the following options

### DTE Pin-Out

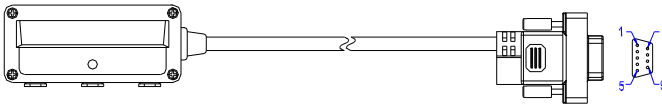

PIN-OUT CONFIGURATION			
2.	TX	7.	CTS
3.	RX	8.	RTS
5.	GND	9	+5V Input

### DCE Pin-Out

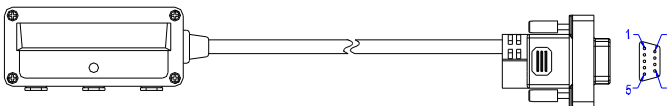

PIN-OUT CONFIGURATION			
2.	RX	7.	RTS
3.	RX	8.	CTS
5.	GND	9	+5V Input



# Technical Specification

<b>Power Requirement</b> Input Voltage Power Consumption Operating Current	5V $\pm$ 10% VDC 0.6 watts 120 mA
<b>Operational</b> Light Source Optical System Depth of Field  Width of Field Scan Rate Minimum Bar Width Print Contrast Indicators (LED) Beeper Operation System Interface	617nm visible LED Linear CCD array 280 mm (UPC/EAN 100%, PCS=90%) 180 mm @ 200 mm of depth 330 scans per second 0.1 mm (0.07 mm actually); (Code 39, PCS=90%) 30% @ UPC/EAN 100% Two-color LED (green & red) Programmable tone & beep time Keyboard, RS-232C, HID USB, Virtual COM USB
<b>Environment</b> Operating Temperature Storage Temperature Humidity Ambient Light Immunity Drop Durability	0°C ~ 55°C (32°F ~ 131°F ) -20°C ~ 60°C (-4°F ~ 140°F) 20% to 95% (non-condensing) Max. 100,000 Lux Designed to withstand 1.0 m drops
<b>Physical Dimension</b> Height Width Depth Weight Mounting	30.25 mm (1.19") 65.0 mm (2.56") 80.0 mm (3.15") 150 g 3-M2 * 0.4 screw hole
<b>Regulatory</b> EMC	CE & FCC DOC compliance, VCCI, BSMI

## Technical Specification (Continued)

<b>Decode Symbology</b>	UPC/JAN/EAN, UPC A & E, EAN-8, EAN-13, ISBN/ISSN, Code 39, Codabar, Code 128, EAN 128, Code 93, Interleave 2 of 5, Addendum 2 or 5, IATA Code, MSI/Plessey, Chinese Postal Code, Code 32 (Italian Pharmacode), Industrial 2 of 5, Standard 2 of 5, Matrix 2 of 5 (JAP), Code 11, GS1 DataBar, Telepen
-------------------------	---

# Dimension

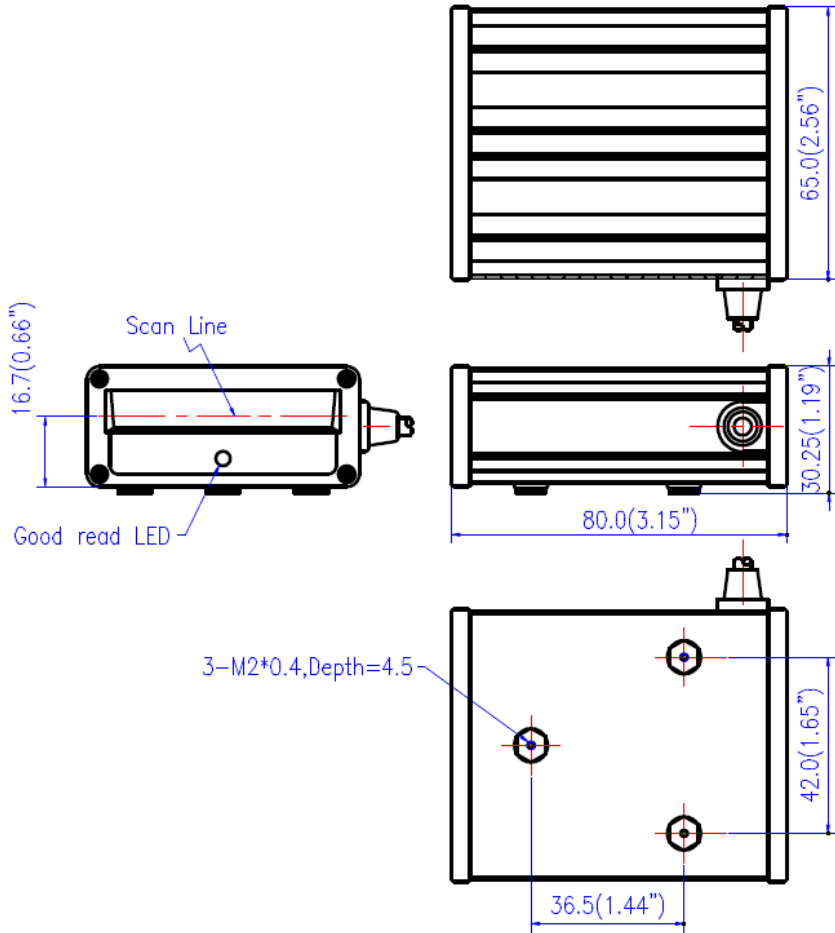

# Programming Guide

Scanning a series of programming bar code labels can configure the scanner. This allows decoding options and interface protocols to be tailored to a specific application. The configuration is stored in non-volatile memory and will not be lost by removing power from the scanner.

The scanner must be properly powered before programming. For RS-232C type scanners, an external power adapter might be necessary to supply DC power to the scanner.

During the programming mode, the scanner will acknowledge a good and valid reading with a short beep. It will give long beeps for either an invalid or bad reading.

See the Default Parameter section for all the programmable parameters. The default settings will be restored whenever the "Reset" programming label is scanned.



# Programming Procedure

Below is the programming procedure by using barcodes in this guide.

1. Power up the scanner.
2. Scan the **Start of Configuration** barcode.
3. Scan the barcode for the desired feature. Multiple features can be enabled/disabled before scanning the **End of Configuration** barcode.
4. Scan the **End of Configuration** barcode and save the new configuration.
5. To give up a configuration change, power off the scanner before scanning the **End of Configuration** barcode or scan the **Abort** barcode.
6. For some parameter setting, such as barcode length and identifier code, it is required to scan the **Set** barcode to save the configuration.

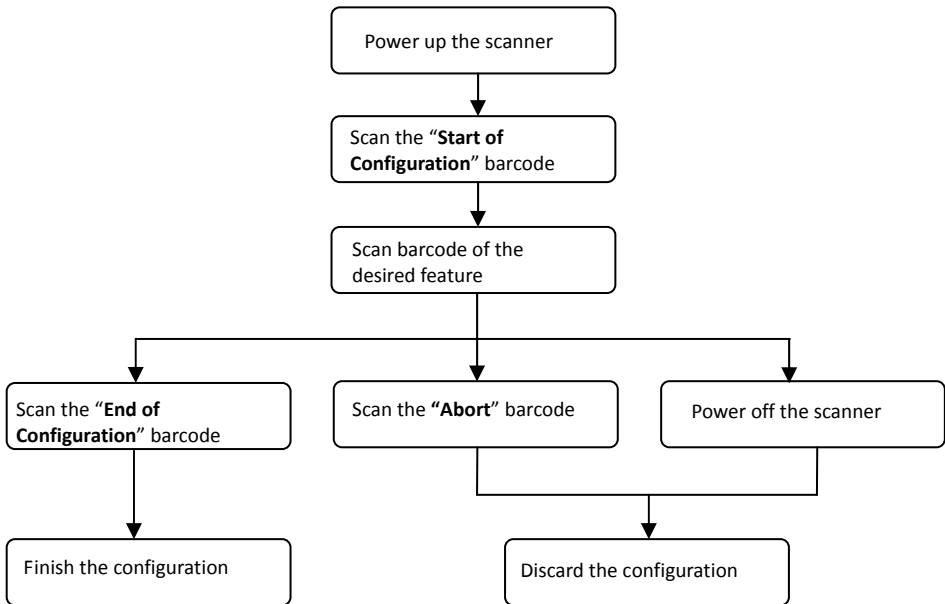

Default values are highlighted in **gray background**.

## Default Parameters

This table gives the default settings of all the programmable parameters. The default settings would be restored whenever the scanner reads the "Reset" programming label in programming mode. If you wish to change any setting, scan the appropriate barcodes below.

### Scanner Operation

Parameter	Default
Same code delay	500msec
Scan mode	Auto scan
Beeping frequency	Medium
Beeping duration	50ms
LED/Beep before data transmission	On
Blink mode timer	500ms
Power save	Off
Header and trailer	None
Inter message delay	None
Inter character delay	None

### Interface Communication

Parameter	Default
<b>RS-232 Interface</b>	
Baud rate	9600
Parity	None
Data Bits	8
Stop Bit	1
RTS/CTS	Off
Terminator	<CR><LF>
<b>Keyboard Wedge Interface</b>	
Terminal Type	PC/AT
Keyboard	US keyboard
Terminator	Enter
<b>USB Interface</b>	
Terminator type	Enter
Code mode	Scan code
Keyboard	US keyboard
<b>Wand Emulation</b>	
Wand emulation speed	Normal
Data output	Black=high

## Symbologies

Parameter	Default
<b>Decoder Selection</b>	
EAN/UPC	Enable
Code 39	Enable
Code 32	Disable
Codabar	Enable
ITF 2 of 5	Enable
MSI	Disable
Chinese Post Code	Disable
Code 93	Enable
Code 128	Enable
EAN-128	Disable
Telepen	Disable
Code 11	Disable
Standard 2 of 5	Disable
Industrial 2 of 5	Disable
Matrix 2 of 5	Disable
GS1 DataBar	Disable
<b>Code Identifiers</b>	
Identifier code as factory standard	Disable
Identifier code as AIM standard	Disable
Code 39 identifier code	M
ITF 2 of 5 identifier code	I
Chinese post code identifier code	H
UPC-A identifier code	A
UPC-E identifier code	E
EAN-13 identifier code	F
EAN-8 identifier code	FF
Codabar identifier code	N
Code 128 identifier code	K
Code 93 identifier code	L
MSI identifier code	P
Code 11 identifier code	O
Standard 2 of 5 identifier code	S
Industrial 2 of 5 identifier code	D
Matrix 2 of 5 identifier code	G
GS1 DataBar identifier code	RS
GS1 DataBar Limited identifier code	RL

GS1 DataBar Expanded identifier code		RX
<b>Barcode Length</b>		
Codabar Code 11 Standard 2 of 5 Industrial 2 of 5 Matrix 2 of 5	maximum	32
	minimum	6
Code 39 Code 93 Code 128	maximum	62
	minimum	3
Chinese Post Code	maximum	16
	minimum	10
MSI ITF 2 of 5	maximum	32
	minimum	4
GS1 DataBar GS1 DataBar Limited	maximum	14
	minimum	14
GS1 DataBar Expanded	maximum	48
	minimum	6

## Data Formatting

Code	Message Format
EAN-13	D1 D2 D3 D4 D5 D6 D7 D8 D9 D10 D11 D12 D13
EAN-8	D1 D2 D3 D4 D5 D6 D7 D8
UPC-A	D1 D2 D3 D4 D5 D6 D7 D8 D9 D10 D11 D12
UPC-E	D1 D2 D3 D4 D5 D6 D7 D8
Code 128	D1-Dx (default 3~62)
EAN-128	C1 D1-Dx (default 3~62)
Code 39	D1-Dx (default 3~62)
Codabar	D1-Dx (default 6~32)
ITF 2 of 5	D1-Dx (default 6~32)
Chinese Post Code	D1-Dx (default 8~32)
Code 93	D1-Dx (default 3~32)
MSI	D1-Dx (default 6~32)

## Trigger Command Format

(Only for RS-232C and USB-Virtual COM Port)

Level Trigger Command	
Command	Description
<ESC>A0<CR>	<ul style="list-style-type: none"> <li>When the scanner receives this command, the CCD/laser would light up and start scanning barcodes entering its scan field.</li> <li>The light would be switched off when the scanner receives a trigger off command.</li> </ul>
Edge Trigger Command	
Command	Description
<ESC>A0.mm<CR>	<ul style="list-style-type: none"> <li>When the scanner receives this command, the CCD/laser would light up and start scanning barcodes entering its scan field.</li> <li>The light would remain on until the scanner reads a barcode or until "mm" period is over (mm=01~60, unit: second).</li> <li>The edge trigger command is not controlled by the trigger off command.</li> </ul>
<ESC>A2<CR>	<ul style="list-style-type: none"> <li>When the scanner receives this command, the CCD/laser light would light up and remain on but the device can only scan once.</li> <li>The light would be switched off when the scanner receives a trigger off command.</li> </ul>
<ESC>A2.mm<CR>	<ul style="list-style-type: none"> <li>When the scanner receives this command, the CCD/laser light would light up and remain on until "mm" period is over.</li> <li>If the scanner read a barcode before "mm" period is over, the light-off countdown would re-start.</li> <li>The scanner is not controlled by the trigger off command.</li> </ul>
Trigger Off Command	
Command	Description
<ESC>A1<CR>	<ul style="list-style-type: none"> <li>The CCD/laser light would be switched off when the scanner receives a trigger off command.</li> </ul>

Example:

- Sending <ESC> "A0" <CR> (0x1b 0x41 0x30 0x0d) to scan module will activate the module for scanning.
- Sending <ESC> "A1" <CR> (0x1b 0x41 0x31 0x0d) to scan module will turn off the scan.

# Parameter Setting

---



Start Of Configuration

---

## Scanner Operation

### System Function Setting

Barcode Value	Barcode Label	Description
--		Reset (return to factory default)
%/		Display firmware version
++		Abort: exit programming mode with no update
KE94		Return to customer default
KE95		Save as customer default



End Of Configuration

---



Start Of Configuration

**Interface Setting**

Barcode Value	Barcode Label	Description
KE97		Return to USB default
KE99		Return to RS-232 default
KE01		Enable Keyboard wedge interface
KE87		Enable USB virtual COM (Virtual COM driver required. For installation steps refer to Appendix 1.)
KE01		Enable IBM PC/AT/PS/2 Keyboard emulation
KE05		Enable stand-alone keyboard (Required no keyboard or key simulator. Only available for special firmware version.)
KE98		Enable wand emulation (Only available for special firmware version.)
KE77		Enable OPOS/JPOS (Available for USB interface only and requires driver. For RS-232 interface, the scanner needs reset and identifier code has to be enabled.)



End Of Configuration



Start Of Configuration

## Operation Function Setting

### Good Read Beeper Tone Selection

Barcode Value	Barcode Label	Description
GR02		Low beeper tone
GR01		Medium beeper tone
GR03		High beeper tone
GR05		Speaker disable

### Beeper Sound Selection

Barcode Value	Barcode Label	Description
GR13		Very short (5 ms)
GR12		Short (20 ms)
GR11		Medium (50 ms)
GR10		Long (100 ms)
GR14		Very Long (200 ms)
GR15		Ultra long (500 ms)



End Of Configuration









Start Of Configuration

### Beeper Volume Selection

Barcode Value	Barcode Label	Description
GR20		Loud
GR21		Medium
GR22		Slight

### Beeper Timing Selection

Barcode Value	Barcode Label	Description
LB00		LED/Beep after transmission <ul style="list-style-type: none"> <li>Use this barcode to indicate a “good read” after a barcode has been successfully decoded.</li> </ul>
LB01		LED/Beep before transmission <ul style="list-style-type: none"> <li>Use this barcode to indicate a “good read” before successfully transmitting the barcode data to the host.</li> </ul>
LB03		Power-on tone enable
LB04		Power-on tone disable



End Of Configuration



Start Of Configuration

### Scan Function Setting

Barcode Value	Barcode Label	Description
SM01		Trigger mode <ul style="list-style-type: none"> <li>The scanner becomes inactive once the data is transmitted. It must be triggered to active again.</li> </ul>
SM02		Auto scan mode <ul style="list-style-type: none"> <li>The scanner will actively scan and decode barcodes, and the same barcode cannot be read twice.</li> </ul>
SM05		Repeat mode <ul style="list-style-type: none"> <li>It is similar to auto scan mode, but double reading on the same barcode is permitted if uses trigger.</li> </ul>



The trigger mode is used when the module is connected to a host with trigger via RS-232 cable with 2 housing connectors.



End Of Configuration

Start Of Configuration

---

**Power Save Mode Selection**

Barcode Value	Barcode Label	Description
MT00		Power save mode off
MT01		Power save after 5 min
MT02		Power save after 10 min
MT03		Power save after 20 min
MT04		Power save after 30 min
MT05		Power save after 60 min
MT12		Power save after every trigger scan

**\*Power Save mode:** After the scanner has been inactive for a period of time, the device powers down to reduce power consumption.



End Of Configuration



Start Of Configuration

**Blink Mode Programming (Available for Auto Scan mode only)**

Barcode Value	Barcode Label	Description
LS00		Blink Mode off. Module never enters blink mode
LS01		Blink mode timer 5 s
LS02		Blink mode timer 10 s
LS03		Blink mode timer 15 s
LS04		Blink mode timer 20 s
LS05		Blink mode timer 30 s
LS06		Blink mode timer 60 s
LS15		Light beam blinks in blink mode



The blink mode is design to protect the LED and prolong its working hours. The scanner would automatically switch to the blink mode after being idle for a specific period of time. To stop the blinking when the scanner is in blink mode, press the “TEST” button.



End Of Configuration



Start Of Configuration

Barcode Value	Barcode Label	Inter Message Delay	
		Description	
IM01		0 ms	
IM02		100 ms	
IM03		500 ms	
IM04		1000 ms	

Barcode Value	Barcode Label	Inter Character Delay	
		Description	
IC01		0 ms	
IC05		2 ms	
IC00		5 ms	
IC02		10 ms	
IC03		20 ms	
IC04		50 ms	



End Of Configuration

Start Of Configuration

---

## Same Code Delay

Barcode Value	Barcode Label	Description
SD01		Same code delay time 50 ms
SD02		Same code delay time 100 ms
SD03		Same code delay time 200 ms
SD04		Same code delay time 300 ms
SD05		Same code delay time 400 ms
SD06		Same code delay time 500 ms
SD07		Same code delay time 600 ms
SD08		Same code delay time 700 ms
SD09		Same code delay time 800 ms
SD10		Same code delay time 900 ms
SD11		Same code delay time 1000 ms
SD12		Same code delay time Infinite



End Of Configuration



Start Of Configuration

---

## Interface Configuration

### RS-232C Interface Setting

#### Same Code Delay

Barcode Value	Barcode Label	Description
BR09		115200
BR08		57600
BR00		38400
BR01		19200
BR02		9600
BR03		4800
BR04		2400
BR05		1200



End Of Configuration



Start Of Configuration

### Parity Bit

Barcode Value	Barcode Label	Description
PB01		Even parity
PB02		Odd parity
PB03		Mark parity
PB04		Space parity
PB05		None parity

### Stop Bit

Barcode Value	Barcode Label	Description
SB01		1 stop bit
SB02		2 stop bit

### Data Bit

Barcode Value	Barcode Label	Description
DB07		7 data bit
DB08		8 data bit



End Of Configuration





Start Of Configuration

### Handshaking Protocol

Barcode Value	Barcode Label	Description
HP01		None handshaking
HP02		ACK/NAK
HP03		Xon/Xoff
HP04		RTS/CTS
LB07		Enable beeper on <BEL> character
LB08		Ignore beep on <BEL> character
LB09		Disable ACK/NAK timeout beeper
RT01		ACK/NAK response time 300 ms
RT03		ACK/NAK response time 500 ms
RT05		ACK/NAK response time 1 s
RT02		ACK/NAK response time 2 s
RT04		ACK/NAK response time 3 s
RT06		ACK/NAK response time 5 s
RT07		ACK/NAK response time infinity



End Of Configuration

Start Of Configuration

---

**Message Terminator**

<b>Barcode Value</b>	<b>Barcode Label</b>	<b>Description</b>
DT11		RS-232 message terminator—none
DT12		RS-232 message terminator—CR/LF
DT13		RS-232 message terminator—CR
DT14		RS-232 message terminator—LF
DT15		RS-232 message terminator—H-tab
DT16		RS-232 message terminator—STX/ETX
DT17		RS-232 message terminator—EOT















End Of Configuration



Start Of Configuration

## Keyboard Wedge and USB Interface Setting

### Language Support

Barcode Value	Barcode Label	Description
KL00		International Keyboard mode (ALT mode)
KL01		Keyboard language support — USA
KL02		Keyboard language support — UK
KL03		Keyboard language support — Germany
KL04		Keyboard language support — French
KL05		Keyboard language support — Spanish
KL06		Keyboard language support — Italian
KL07		Keyboard language support — Switzerland
KL08		Keyboard language support — Sweden
KL09		Keyboard language support — Belgium
KL10		Keyboard language support — Portugal
KL11		Keyboard language support — Turkish
KL15		Keyboard language support — Japanese



End Of Configuration



Start Of Configuration

**Keyboard Setting**

Barcode Value	Barcode Label	Description
CP00		Capital lock on
CP01		Capital lock off
CP05		Function key emulation enable
CP06		Function key emulation disable
CP18		Send number as normal data
CP19		Send number as keypad data
CP20		Alphabet follow as keyboard
CP21		Alphabet always upper case
CP22		Alphabet always Lower case

**Message Terminator**

Barcode Value	Barcode Label	Description
DT01		Keyboard terminator---none
DT02		Keyboard terminator---Enter
DT03		Keyboard terminator---H-TAB



End Of Configuration



Start Of Configuration

## Wand Emulation Setting

Wand emulation is a standard interface but requires special firmware. If needed, please contact your distributor.

Barcode Value	Barcode Label	Description
WD01		All barcode will be decoded and transmitted in that symbology
WD02		Enable Wand output data format as Code 39
WO01		<p>Wand emulation data output black = high</p> <ul style="list-style-type: none"> <li>Scan this barcode to set quiet zones and spaces low and bars =high.</li> </ul>
WO02		<p>Wand emulation data output black=low</p> <ul style="list-style-type: none"> <li>Scan this barcode to set quiet zones and spaces high and bars=low</li> </ul>
WO03		<p>Idle = high</p> <ul style="list-style-type: none"> <li>Idle state refers to the TTL logic level of the Wand Emulation signal when not in use</li> </ul>
WO04		<p>Idle = low</p> <ul style="list-style-type: none"> <li>Idle state refers to the TTL logic level of the Wand Emulation signal when not in use</li> </ul>
WS01		<p>Wand emulation speed---Low</p> <ul style="list-style-type: none"> <li>This option allows the transmission of wand emulation at 1ms narrow element width</li> </ul>
WS02		<p>Wand emulation speed---medium</p> <ul style="list-style-type: none"> <li>This option allows the transmission of wand emulation at 600us narrow element width</li> </ul>



End Of Configuration



Start Of Configuration

**Wand Emulation Speed**

<b>Barcode Value</b>	<b>Barcode Label</b>	<b>Description</b>
WS03		Wand emulation speed---normal
WS04		Wand emulation speed---high <ul style="list-style-type: none"> <li>This option allows the transmission of wand emulation at 300us narrow element width</li> </ul>
WS05		Wand emulation speed---higher <ul style="list-style-type: none"> <li>This option allows the transmission of wand emulation at 100 us narrow element width</li> </ul>
WS00		Wand emulation narrow/wide ratio 1:2
WS08		Wand emulation narrow/wide ratio 1:3



End Of Configuration



Start Of Configuration

## The Symbolologies

### Codabar Parameter Setting

Barcode Value	Barcode Label	Description
RC02		Codabar enable
RD02		Codabar disable
CB05		Codabar start/stop character transmission — none
CB06		Codabar start/stop character transmission — A,B,C,D
CB07		Codabar start/stop character transmission — DC1~DC4
CB08		Codabar start/stop character transmission — a/t,b/n,c/*,d/e
CB09		Codabar maximum length setting
CB10		Codabar minimum length setting
SET		Confirm to save this setting (required for reading full ASCII table and length setting)
CB11		Codabar concatenation disable
CB12		Codabar concatenation enable



End Of Configuration



Start Of Configuration

**Codabar (Continued)**

<b>Barcode Value</b>	<b>Barcode Label</b>	<b>Description</b>
CB13		No check character
CB14		Validate modulo 16, but don't transmit
CB15		Validate modulo 16 and transmit
DC50		Codabar data redundant check=off
DC51		Codabar data redundant check=1
DC52		Codabar data redundant check=2
DC53		Codabar data redundant check=3



End Of Configuration





Start Of Configuration

## Code 39 Parameter Setting

Barcode Value	Barcode Label	Description
RC01		Code 39 enable
RD01		Code 39 disable
RC13		Code 32 enable
RD13		Code 32 disable
DC00		Code 39 data redundant check=off
DC01		Code 39 data redundant check=1
DC02		Code 39 data redundant check=2
DC03		Code 39 data redundant check=3
3901		Standard code 39
3902		Full ASCII code 39
3903		Code 39 start/stop character transmission
3904		Code 39 start/stop character without transmission



End Of Configuration



Start Of Configuration

**Code 39 (Continued)**

Barcode Value	Barcode Label	Description
3905		Code 39 check digit calculate and transmit
3906		Code 39 check digit calculate but without transmit
3907		No check character
3908		Code 39 maximum length setting
3909		Code 39 minimum length setting
SET		Confirm to save this setting (required for reading full ASCII table and length setting)
3910		Code 39 concatenation enable
3911		Code 39 concatenation disable
3912		Code 32 (Italian pharmacy) transmit "A" character
3913		Code 32 (Italian pharmacy) without transmit "A" character



End Of Configuration



Start Of Configuration

## Code 93 Parameter Setting

Barcode Value	Barcode Label	Description
RC08		Code 93 enable
RD08		Code 93 disable
DC30		Code 93 data redundant check=off
DC31		Code 93 data redundant check=1
DC32		Code 93 data redundant check=2
DC33		Code 93 data redundant check=3
9301		Code 93 maximum length setting
9302		Code 93 minimum length setting

SET



Confirm to save this setting (required for reading full ASCII table and length setting)

9303



Code 93 check digit calculate but without transmit

9304



Code 93 check digit not calculate and without transmit

9305



Code 93 check digit calculate and transmit



End Of Configuration



Start Of Configuration

### Code 128 Parameter Setting

Barcode Value	Barcode Label	Description
RC06		Code 128 enable
RD06		Code 128 disable
RC10		EAN-128 enable
RD10		EAN-128 disable
DC40		Code 128 data redundant check=off
DC41		Code 128 data redundant check=1
DC42		Code 128 data redundant check=2
DC43		Code 128 data redundant check=3
1801		Code128 FNC2 concatenation enable
1802		Code128 FNC2 concatenation disable
1803		No check character
1804		Calculate but not transmitted
1805		Calculate and transmit
1806		Code 128 maximum length setting
1807		Code 128 minimum length setting

SET		Confirm to save this setting (required for reading full ASCII table and length setting)
-----	--	---



End Of Configuration



Start Of Configuration

## Chinese Post Code Parameter Setting

Barcode Value	Barcode Label	Description
RC05		Chinese post code enable
RD05		Chinese post code disable
DC60		Chinese post code data redundant check=off
DC61		Chinese post code data redundant check=1
DC62		Chinese post code data redundant check=2
DC63		Chinese post code data redundant check=3
SZ01		Chinese post code maximum length setting
SZ02		Chinese post code minimum length setting

SET



Confirm to save this setting (required for reading full ASCII table and length setting)



End Of Configuration



Start Of Configuration

**MSI/Plessey Parameter Setting**

Barcode Value	Barcode Label	Description
RC14		MSI enable
RD14		MSI disable
DC70		MSI data redundant check= off
DC71		MSI data redundant check=1
DC72		MSI data redundant check=2
DC73		MSI data redundant check=3
MS01		MSI/Plessey maximum length setting
MS02		MSI/Plessey minimum length setting

SET		Confirm to save this setting (required for reading full ASCII table and length setting)
-----	--	---

MS03		MSI/Plessey double check digit calculate but not transmit
MS04		MSI/Plessey double check digit without calculate and transmit
MS05		MSI/Plessey double check digit calculate but only first digit transmit
MS06		MSI/Plessey double check digit calculate and both transmit
MS07		MSI/Plessey single check digit calculate but without transmit
MS08		MSI/Plessey single check digit calculate and transmit



End Of Configuration



Start Of Configuration

## Code 11 Interface Setting

Barcode Value	Barcode Label	Description
RC07		Code 11 enable
RD07		Code 11 disable
1101		Code 11 maximum length setting
1102		Code 11 minimum length setting

SET



Confirm to save this setting (required for reading full ASCII table and length setting)

1103		Code 11 one check digit verification
1104		Code 11 two check digit verification
1105		Two Check for Code 11 check digit if code length is longer than 10 characters
1106		Disable verification
1107		Code 11 check digit transmitted
1108		Code 11 check digit not transmitted



End Of Configuration



Start Of Configuration

### ITF 2 of 5 Parameter Setting

Barcode Value	Barcode Label	Description
RC04		ITF 2 of 5 enable
RD04		ITF 2 of 5 disable
RC09		IATA code enable
RD09		IATA disable
DC80		ITF 25 data redundant check=off
DC81		ITF25 data redundant check=1
DC82		ITF25 data redundant check=2
DC83		ITF25 data redundant check=3
IT03		ITF 2 of 5 no check character
IT04		ITF 2 of 5 check digit calculate and transmit
IT05		ITF 2 of 5 check digit calculate but without transmit



End Of Configuration





Start Of Configuration

---

**ITF 2 of 5 (Continued)**

Barcode Value	Barcode Label	Description
IT01		ITF 2 of 5 code maximum length setting
IT02		ITF 2 of 5 code minimum length setting
IT06		ITF 2 of 5 one fixed length setting
IT07		ITF 2 of 5 two fixed length setting

SET



Confirm to save this setting (required for reading full ASCII table and length setting)



End Of Configuration



Start Of Configuration

## Standard 2 of 5 Parameter Setting

Barcode Value	Barcode Label	Description
RC22		Standard 2 of 5 code enable
RD22		Standard 2 of 5 code disable
D051		Standard 2 of 5 code maximum length setting
D052		Standard 2 of 5 code minimum length setting

SET		Confirm to save this setting (required for reading full ASCII table and length setting)
-----	--	---

D053		Standard 2 of 5 code no check character
D054		Standard 2 of 5 code check digit calculate and transmit
D055		Standard 2 of 5 code check digit calculate but without transmit



End Of Configuration



Start Of Configuration

## Industrial 2 of 5 Parameter Setting

Barcode Value	Barcode Label	Description
RC21		Industrial 2 of 5 code enable
RD21		Industrial 2 of 5 code disable
D251		Industrial 2 of 5 code maximum length setting
D252		Industrial 2 of 5 code minimum length setting

SET



Confirm to save this setting (required for reading full ASCII table and length setting)

D253		Industrial 2 of 5 code no check character
D254		Industrial 2 of 5 code check digit calculate and transmit
D255		Industrial 2 of 5 code check digit calculate but without transmission



End Of Configuration



Start Of Configuration

### UPC/EAN/JAN Parameter Setting

Barcode Value	Barcode Label	Description
RC11		EAN convert to ISSN/ISBN enable
RD11		EAN convert to ISSN/ISBN disable
RC03		UPC/EAN/JAN enable
RD03		UPC/EAN/JAN disable
UE01		UPC/EAN/JAN all enable
UE02		EAN-8 or EAN-13 enable
UE03		UPC-A and EAN-13 enable
UE04		UPC-A and UPC-E enable
UE05		UPC-A enable
UE06		UPC-E enable
UE07		EAN-13 enable
UE08		EAN-8 enable
UE09		UPC/EAN Addendum disable



End Of Configuration



Start Of Configuration

---

**UPC/EAN/JAN (Continued)**

Barcode Value	Barcode Label	Description
UE10		Add on 5 only
UE11		Add on 2 only
UE12		Add on 2 or 5
UE13		Force UPC-E to UPC-A format enable
UE14		Force UPC-E to UPC-A format disable
UE15		Force UPC-A to EAN-13 format enable
UE16		Force UPC-A to EAN-13 format disable
UE44		Force EAN-8 to EAN-13 format enable
UE45		Force EAN-8 to EAN-13 format disable
UE17		Transmit UPC-A check digit enable
UE18		Transmit UPC-A check digit disable
UE19		Transmit UPC-E leading character enable
UE20		Transmit UPC-E leading character disable
UE21		Transmit UPC-E check digit enable
UE22		Transmit UPC-E check digit disable

---



End Of Configuration



Start Of Configuration

**UPC/EAN/JAN (Continued)**

Barcode Value	Barcode Label	Description
UE23		Transmit EAN-8 check digit enable
UE24		Transmit EAN-8 check digit disable
UE25		Transmit EAN-13 check digit enable
UE26		Transmit EAN-13 check digit disable
UE27		Transmit UPC-A leading character enable
UE28		Transmit UPC-A leading character disable
UE30		Add-on format with separator
UE31		Add-on format without separator
UE60		EAN-13 country code first "0" can transmitted
UE61		EAN-13 country code first:"0" can't transmitted
UE66		EAN-13 with first 0 ID code same as "UPC-A"
UE67		EAN-13 with first 0 ID code same as "EAN-13"
DC10		UPC-A data redundant check=off
DC11		UPC-A data redundant check=1



End Of Configuration



Start Of Configuration

---

**UPC/EAN/JAN (Continued)**

Barcode Value	Barcode Label	Description
DC12		UPC-A data redundant check=2
DC13		UPC-A data redundant check=3
DC14		UPC-E data redundant check=off
DC15		UPC-E data redundant check=1
DC16		UPC-E data redundant check=2
DC17		UPC-E data redundant check=3
DC20		EAN-13 data redundant check=off
DC21		EAN-13 data redundant check=1
DC22		EAN-13 data redundant check=2
DC23		EAN-13 data redundant check=3
DC24		EAN-8 data redundant check=off
DC25		EAN-8 data redundant check=1
DC26		EAN-8 data redundant check=2
DC27		EAN-8 data redundant check=3
UE32		EAN/UPC +add-on (none mandatory)
UE33		EAN/UPC +add-on (mandatory)



End Of Configuration



Start Of Configuration

---

**UPC/EAN/JAN (Continued)**

UE35		EAN/UPC +add-on mandatory for 978/977 bookland (Supplement requirement, not sent for other)
UE38		EAN/UPC +add-on mandatory for 978/977 bookland (Supplement requirement, optionally for other)
UE42		EAN/UPC +add-on mandatory for 491 Japanese bookland (Supplement requirement, not sent for other)
UE43		EAN/UPC +add-on mandatory 491 Japanese bookland (Supplement requirement, optionally for other)



End Of Configuration



Start Of Configuration

---

## Telepen Parameter Setting

Barcode Value	Barcode Label	Description
RC25		Telepen enable
RD25		Telepen disable
TE03		Telepen numeric mode enable
TE04		AIM Telepen enable



End Of Configuration



Start Of Configuration

### Matrix 2 of 5 Parameter Setting

Barcode Value	Barcode Label	Description
RC12		Matrix 2 of 5 enable
RD12		Matrix 2 of 5 disable
D151		Matrix 2 of 5 maximum length setting
D152		Matrix 2 of 5 minimum length setting
SET		Confirm to save this setting (required for reading full ASCII table and length setting)
D153		Matrix 2 of 5 no check character
D154		Matrix 2 of 5 check digit calculate and transmit
D155		Matrix 2 of 5 check digit calculate but without transmission



End Of Configuration



Start Of Configuration

## GS1 DataBar Parameter Setting

There are 7 kinds of barcodes in the GS1 DataBar family and they are categorized into three groups. Barcode types in the same group use the same barcodes for setting.

Group	Representative	Contents
Group 1	GS1 DataBar Omnidirectional (Formally RSS-14)	GS1 DataBar Omnidirectional GS1 DataBar Truncated GS1 DataBar Stacked GS1 DataBar Stacked Omnidirectional
Group 2	GS1 DataBar Limited (Formally RSS Limited)	GS1 DataBar Limited
Group 3	GS1 DataBar Expanded (Formally RSS Expanded)	GS1 DataBar Expanded GS1 DataBar Expanded Stacked

### GS1 DataBar Omnidirectional (Formally RSS-14)

Barcode Value	Barcode Label	Description
RC15		GS1 DataBar Omnidirectional enable
RD15		GS1 DataBar Omnidirectional disable
SS00		Transmit GS1 DataBar Omnidirectional check digit
SS01		Do not transmit GS1 DataBar Omnidirectional check digit
SS02		Transmit GS1 DataBar Omnidirectional application ID (01)
SS03		Do not transmit GS1 DataBar Omnidirectional application ID (01)
SS05		GS1 DataBar Omnidirectional /EAN-128 emulation enable
SS04		GS1 DataBar Omnidirectional /EAN-128 emulation disable



End Of Configuration

Start Of Configuration

---

**GS1 DataBar Limited (Formally RSS Limited)**

Barcode Value	Barcode Label	Description
RC16		GS1 DataBar Limited enable
RD16		GS1 DataBar Limited disable
SS10		Transmit GS1 DataBar Limited check digit
SS11		Don't transmit GS1 DataBar Limited check digit
SS12		Transmit GS1 DataBar limited application ID (01)
SS13		Do not transmit GS1 DataBar limited application ID



End Of Configuration



Start Of Configuration

### GS1 DataBar Expanded (Formally RSS Expanded)

Barcode Value	Barcode Label	Description
RC17		GS1 DataBar Expanded enable
RD17		GS1 DataBar Expanded disable
SS07		GS1 DataBar Expanded/EAN-128 emulation enable
SS06		GS1 DataBar Expanded/EAN-128 emulation disable
SS08		GS1 DataBar Expanded check digital enable
SS09		GS1 DataBar Expanded check digital disable
SS16		Transmit GS1 DataBar Expanded application ID (01)
SS17		Do not transmit GS1 DataBar Expanded application ID



End Of Configuration



Start Of Configuration

## Data Editing

### Identifier Code

Barcode Value	Barcode Label	Description
IS00		Disable identifier code
IS01		Enable identifier code table as factory standard
IS03		Enable identifier code table as AIM standard.
CI01		Code 39 identifier code setting
CI02		ITF 2 of 5 identifier code setting
CI03		Chinese Post Code identifier code setting
CI04		UPC-E identifier code setting
CI05		UPC-A identifier code setting
CI06		EAN-13 identifier code setting
CI07		EAN-8 identifier code setting

SET		Confirm to save this setting (required for reading full ASCII table and length setting)
-----	--	---



End Of Configuration



Start Of Configuration

Barcode Value	Barcode Label	Description
CI08		Codabar identifier code setting
CI09		Code 128 identifier code setting
CI10		Code 93 identifier code setting
CI11		MSI identifier code setting
CI12		GS1 DataBar Omnidirectional identifier code setting
CI13		GS1 DataBar Limited identifier code setting
CI14		GS1 DataBar expanded identifier code setting
CI15		Industrial 2 of 5 identifier code setting
CI16		Code 11 Identifier code setting
CI17		Standard 2 of 5 identifier code setting
CI18		Matrix 2 of 5 identifier code setting

SET



Confirm to save this setting (required for reading full ASCII table and length setting)



End Of Configuration



### Header and Trailer

Barcode Value	Barcode Label	Description
CP11		Add code length as header enable (2 digits)
CP12		Add code length as header disable (2 digits)
HT01		Header (Preamble)
HT02		Trailer (Postamble)
HT03		Truncate header character
HT04		Truncate trailer character

SET		Confirm to save this setting (required for reading full ASCII table and length setting)
-----	--	---



## Appendix 1: USB Virtual COM Driver Installation

Contact your distributor to get the driver and follow the steps below to enable USB virtual COM port.

1. Connect the handheld scanner and the host (e.g. a PC) with a USB interface cable.
2. Enable USB virtual COM port with programming barcodes on page 17.
3. After the programming, the host would request driver installation. Browse your files to locate the driver and start installation.
4. The USB virtual COM port is ready for use after driver installation.

## Appendix 2: Barcode Length Setting

### Introduction

The length of a barcode is the number of characters it contains, including check digits. As listed in the Default Parameters section, each barcode type has different default length. You may change the setting by the following procedure.

To set up barcode length, the parameters to be determined are barcode type and the desired barcode length. Barcode length is consisted of 2 digits. For numbers smaller than 10, you need to add a "0" in the front.

### Example

If the barcode length is 4 to 12 digits, the steps would be as below:

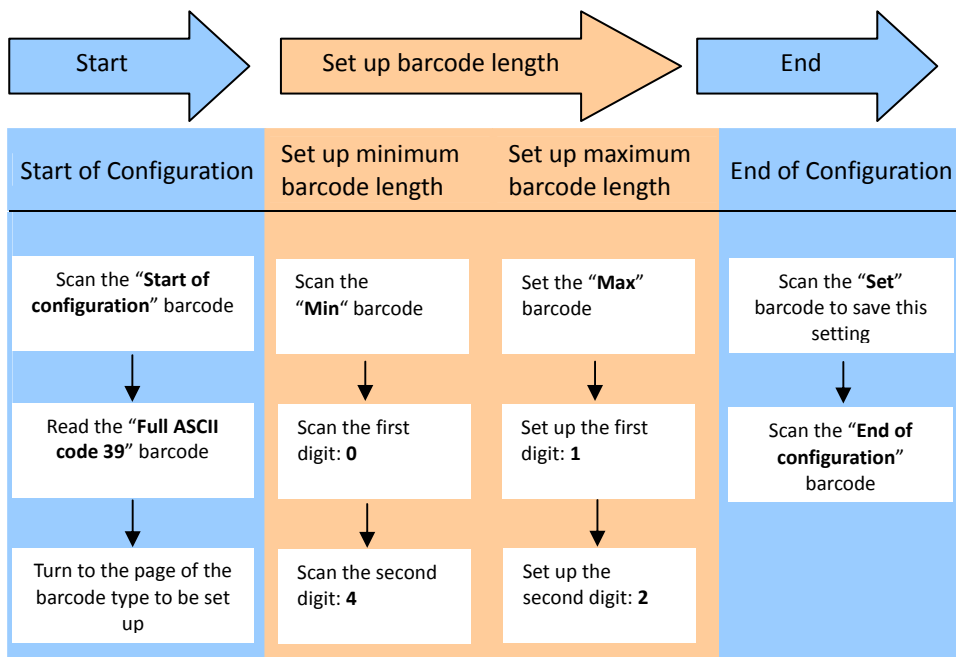

Use the ASCII table (Appendix 3) to set up barcode length. Be sure to enable the full ASCII code 39 option before you start and read the "Set" label to set your choice into memory.



### Appendix 3: Full ASCII Code 39 Table

Code 39	ASCII	Hexa-code	Code 39	ASCII	Hexa-code
	Full ASCII ---NUL	00		Full ASCII ---SI Function key----"Shift"	0F
	Full ASCII ---SOH Function key----"Ins"	01		Full ASCII ---DLE Function key----"5(num)"	10
	Full ASCII ---STX Function key----"Del"	02		Full ASCII ---DC1 Function key----"F1"	11
	Full ASCII ---ETX Function key----"Home"	03		Full ASCII ---DC2 Function key----"F2"	12
	Full ASCII ---EOT Function key----"End"	04		Full ASCII ---DC3 Function key----"F3"	13
	Full ASCII ---ENQ Function key----"Up arrow"	05		Full ASCII ---DC4 Function key----"F4"	14
	Full ASCII ---ACK Function key----"Down arrow"	06		Full ASCII ---NAK Function key----"F5"	15
	Full ASCII ---BEL Function key----"Left arrow"	07		Full ASCII ---SYN Function key----"F6"	16
	Full ASCII ---BS Function key----"Backspace"	08		Full ASCII ---ETB Function key----"F7"	17
	Full ASCII ---HT Function key----"TAB"	09		Full ASCII ---CAN Function key----"F8"	18
	Full ASCII ---LF Function key----"Enter (alpha numeric)"	0A		Full ASCII ---EN Function key----"F9"	19
	Full ASCII ---VT Function key----"right arrow"	0B		Full ASCII ---SUB Function key----"F10"	1A
	Full ASCII ---FF Function key----"PgUp"	0C		Full ASCII ---ESC Function key----"F11"	1B
	Full ASCII ---CR Function key----"Enetr(num.)"	0D		Full ASCII ---FS Function key----"F12"	1C
	Full ASCII ---SO Function key----"PgDn"	0E		Full ASCII ---GS Function key----"ESC"	1D





Start Of Configuration

**Full ASCII Code 39 Table**

Code 39	ASCII	Hexa-code	Code 39	ASCII	Hexa-code
	Full ASCII ---RS Function key-----"CTL(L)"	1E		Full ASCII ----	2D
	Full ASCII ---US Function key-----"ALT(L)"	1F		Full ASCII ---.	2E
	Full ASCII ---SP	20		Full ASCII ---/	2F
	Full ASCII ---!	21		Full ASCII ---0	30
	Full ASCII ---"	22		Full ASCII ---1	31
	Full ASCII ---#	23		Full ASCII ---2	32
	Full ASCII ---\$	24		Full ASCII ---3	33
	Full ASCII ---%	25		Full ASCII ---4	34
	Full ASCII ---&	26		Full ASCII ---5	35
	Full ASCII ---'	27		Full ASCII ---6	36
	Full ASCII --- (	28		Full ASCII ---7	37
	Full ASCII ---)	29		Full ASCII ---8	38
	Full ASCII ---*	2A		Full ASCII ---9	39
	Full ASCII ---+	2B		Full ASCII ---:	3A
	Full ASCII ---,	2C		Full ASCII ---;	3B



End Of Configuration



Start Of Configuration

**Full ASCII Code 39 Table**

Code 39	ASCII	Hexa-code	Code 39	ASCII	Hexa-code
	Full ASCII ---<	3C		Full ASCII ---K	4B
	Full ASCII ---=	3D		Full ASCII ---L	4C
	Full ASCII --->	3E		Full ASCII ---M	4D
	Full ASCII ---?	3F		Full ASCII ---N	4E
	Full ASCII ---@	40		Full ASCII ---O	4F
	Full ASCII ---A	41		Full ASCII ---P	50
	Full ASCII ---B	42		Full ASCII ---Q	51
	Full ASCII ---C	43		Full ASCII ---R	52
	Full ASCII ---D	44		Full ASCII ---S	53
	Full ASCII ---E	45		Full ASCII ---T	54
	Full ASCII ---F	46		Full ASCII ---U	55
	Full ASCII ---G	47		Full ASCII ---V	56
	Full ASCII ---H	48		Full ASCII ---W	57
	Full ASCII ---I	49		Full ASCII ---X	58
	Full ASCII ---J	4A		Full ASCII ---Y	59



End Of Configuration



Start Of Configuration

**Full ASCII Code 39 Table**

<b>Code 39</b>	<b>ASCII</b>	<b>Hexa-code</b>	<b>Code 39</b>	<b>ASCII</b>	<b>Hexa-code</b>
	Full ASCII ---Z	5A		Full ASCII ---i	69
	Full ASCII ---[	5B		Full ASCII ---j	6A
	Full ASCII ---\	5C		Full ASCII ---k	6B
	Full ASCII ---]	5D		Full ASCII ---l	6C
	Full ASCII ---^	5E		Full ASCII ---m	6D
	Full ASCII ---_	5F		Full ASCII ---n	6E
	Full ASCII ---`	60		Full ASCII ---o	6F
	Full ASCII ---a	61		Full ASCII ---p	70
	Full ASCII ---b	62		Full ASCII ---q	71
	Full ASCII ---c	63		Full ASCII ---r	72
	Full ASCII ---d	64		Full ASCII ---s	73
	Full ASCII ---e	65		Full ASCII ---t	74
	Full ASCII ---f	66		Full ASCII ---u	75
	Full ASCII ---g	67		Full ASCII ---v	76
	Full ASCII ---h	68		Full ASCII ---w	77



End Of Configuration



Start Of Configuration

### Full ASCII Code 39 Table

Code 39	ASCII	Hexa-code
	Full ASCII ---x	78
	Full ASCII ---y	79
	Full ASCII ---z	7A
	Full ASCII ---{	7B
	Full ASCII ---	7C
	Full ASCII ---}	7D
	Full ASCII ---~	7E
	Full ASCII ---DEL	7F



End Of Configuration